

WIN PLAY WOODEN WP 1431

PLAYGROUND EQUIPMENT

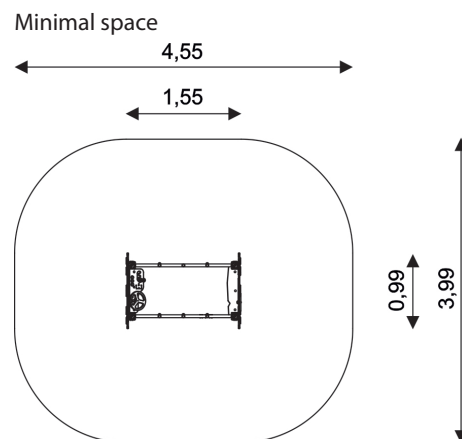

Device Specifications	
Safety zone	16,20 m ²
Length	1,55 m
Width	0,99 m
Total height	1,20 m
Free fall height	1,10 m
Age range	1-8 years
In accordance PN-EN standards	1176-1:2017
Weight of the heaviest part [kg]	10
Dimension of the biggest part [cm]	151x100x1,2
Availability of spare parts	Yes



MATERIAL SPECIFICATION

- 90x90 mm main construction made of impregnated, laminated wood of pine;
- Metal anchors are made of hot dip galvanized steel, protecting from direct contact with the ground to prevent rot and extending the product's life;
- Roofs and panels are made of atmospheric condition resistant HDPE plates;
- Screws covered with plastic caps or made of stainless steel;
- Stainless steel bars and handrails;
- Steel ropes braided with PP, connected by durable plastic elements;

ADDITIONAL COMMENTS

- Depth of foundations on a flat surface 80/70/60 cm;
- No sharp edges or chinks that would pose a danger of jimming the head, fingers or any other body parts;
- The equipment is designed for public playgrounds;
- The equipment render is of an illustrative nature and shows only the general specification of the equipment, but not actual appearance;
- The equipment is suitable for people with disabilities;
- The equipment is certified by an accrediting organization or by certificate of conformity;

SURFACES

Due to the free fall height of the equipment, the PN-EN 1176-1:2017 standard allows the following surfaces: turf/ soil (A,B,C), sand with minimal layer thickness of 30 cm (A,C), synthetic material approved for free fall of 1,10 m (A,B,C).